

SDM630MCT-LoRaWAN

DIN Rail Smart Energy Meter for Long Range Wireless Communication



USER MANUAL

2020 V1.0

Contents

1. Introduction	1
1.1 Unit Characteristics	1
1.2 CT Ratio	1
1.3 Pulse Outputs	1
1.4 LoRaWAN Classes	2
1.5 Active Upload Mode	2
1.6 Join	2
1.7 Communication	2
2. Start Up Screens	5
3. Measurements	5
3.1 Voltage and Current	5
3.2 Frequency and Power factor and Demand	6
3.3 Power	7
3.4 Energy Measurements	8
4 Setting Up	9
4.1 Set-up Entry Methods	10
4.1.1 Menu Option Selection	10
4.1.2 Number Entry Procedure	10
4.2 Setting 1	11
4.2.1 CT2	11
4.2.2 CT1	12
4.2.3 PT2	12
4.2.4 PT1	13
4.2.5 Pulse Output Type	13
4.2.6 Pulse Constant	14
4.2.7 Pulse Duration	15
4.2.8 Demand Interval Time (DIT)	15
4.2.9 Backlight Time	16
4.2.10 System	16
4.2.11 Clear Demand Information	17
4.2.12 Password	18
4.2.13 System Connect	18
4.2.14 Checking Meter Information	19
4.3 Setting 2	22
4.3.1 Join Information	22
4.3.2 Join Mode: OTAA/ABP	24
4.3.3 Re-Join	24
4.3.4 Auto: Upload ON/OFF, Upload Interval Time	24
4.3.5 Join Delay	26
4.3.6 OFF Line	26
4.3.7 Confirm Mode	27
5 Specifications	28

6 Maintenance.....	30
7 Installation.....	30
7.1 Safety.....	30
7.2 EMC Installation Requirements.....	30
7.3 Dimensions.....	31
7.4 Wiring Diagram.....	32
7.4.1 Current and Voltage Input.....	32
7.4.2 Definition of Other Terminals.....	32

1 Introduction

This document provides operating, maintenance and installation instructions .

The unit measures and displays the characteristics of single phase two wire(1p2w) , single phase three wire(1p3w), three phase three wire(3p3w,) and three phase four wire(3p4w) supplies, including kWh, kVAh, kW, kVAh, kVA, PF, Frequency, Voltage, Current, dmd. THD etc. Energy is measured in terms of kWh, kVAh. Maximum demand current can be measured over preset periods of up to 60minutes.

The requisite current input(s) are obtained via current transformers (CT). This meter can be configured to work with a wide range of CTs, giving the unit a wide range of operation. Configuration is password protected.

This unit has a built-in LoRaWAN module which allows long range wireless communication. Two pulse outputs are available for real time energy measurement.

1.1 Unit Characteristics

The Unit can measure and display:

- Line voltage and THD% (total harmonic distortion) of all phases
- Line Frequency
- Currents, Current demands and current THD% of all phases
- Power, maximum power demand and power factor
- Active energy imported and exported
- Reactive energy imported and exported

The unit has password-protected set-up screens for:

- Changing password
- Supply system selection 1p2w, 1p3w, 3p3w, 3p4w
- Demand Interval time, backlight time
- Reset for demand measurements
- Pulse output type/ duration
- Current inputs correction

1.2 CT Ratio

The unit can be configured to operate with different ratio of CTs. The Primary current can up to 9999A. The secondary CT has two options: 1A/5A

1.3 Pulse outputs

The unit provides two pulse outputs. Both pulse outputs are passive type.

Pulse output 1 is configurable. The pulse output can be set to generate pulses to represent total/ import/ export kWh or kVAh.

The pulse constant can be set to generate 1 pulse per:

0.01 = 10 Wh/VAh

0.1 = 100 Wh/VAh

1 = 1 kWh/kVAh

10 = 10 kWh/kVAh

100 = 100 kWh/kVAh

1000=1000 kWh/kVArh

Pulse width: 200/100(default)/60ms.

Pulse output 2 is non-configurable. It is fixed to total kWh. The constant is 3200imp/kWh.

1.4. LoRaWAN Classes

Eastron LoRaWAN energy meter is implement Class C functionality. The device will upload message after receiving the data sent from the network.

1.5 Active Upload Mode

The device also can be customized to active upload mode. Total 30 parameters can be set for automatic uploading.

Interval time can be set from 0 to 255 through communication. 0 means the function is OFF. If there are many parameters, the interval shouldn't be set too short in case of conflicting on data uploading.

The meter will upload automatically once it joins the network. And after the interval time, it will upload again.

The interval time is calculated since the last data uploading. Sometimes the interval time may have around 1-2 minutes difference due to the timer error.

1.6 Join

The unit uses standard LoRaWAN protocol for long range communication. Before Communication, the meter has to join the LoRaWAN network first.

There are two Activation Ways for Joining: OTAA(Over-the-Air Activation) and ABP(Activation by Personalization).

To ensure the meter join gateway successfully, below information must be confirmed:

- I. DevEui, AppEui, Appkey or DevAddr, NwkSKey, AppSKey information are correctly recorded into the gateway.
- II. The Uplink and downlink frequency are same as the gateway.
- III. RX2 (frequency and SF) information are same as the gateway.

If the Join delay function is ON, the meter will join the network with a few seconds delay by random.

1.7 Communication

LoRaWAN meter communicate based on international general purpose protocol. The communication data is placed in data segment of LoRaWAN protocol, they will be appointed follow the specified command format.

The format of standard LoRaWAN is shown below:

Radio PHY layer:							
Preamble	PHDR	PHDR_CRC	PHYPayload				CRC*
			MHDR	MACPayload		MIC	
			MHDR	FHDR	Fport	FRMPayload	MIC
Note: CRC* is only available on uplink messages							

The following description of the text is defined the data in the segment of **FRMPayload** region in LoRaWAN protocol. The software in PC only need to get this part of data from gateway. According to the following protocol definition to parse the data.

The data format and encoding of meter communication protocol are modified based on the Modbus ASCII transmission mode. Remove the start and end characters from the Modbus ASCII transmission mode and change LRC validation to CRC validation.

Encoding of data: communication data is encoded with ASCII, and each byte of data is sent with two ASCII characters.

E.g.: a byte data 0x5b is encoded as two characters: 0x35 and 0x62 (ASCII code 0x35= "5", 0x62= "b")

Command format definition:

I: The data format of the gateway sending the copy command:

Reserved	Function Code	The first Address of The Register to Read Data	The Number of Registers to Read Data	CRC Check Codes
1byte	1byte	2byte	2byte	2byte

Note: the reserved bit is fixed as 0x01

II: the data format returned by the meter after receiving the copy command:

Reserved	Function Code	The Length of Data Returned	Specific Data Returned by The Meter	CRC Check Codes
1byte	1byte	1byte	N byte	2byte

Note: the reserved bit is fixed as 0x01

III: Note: the above commands need to be ASCII, so 1byte data will have 2 characters.

E.g.

1). Suppose to read the current data of the meter L1, the data sent by the gateway is the ASCII coded data as shown in the following table:

Reserved	Function Code			The first Address of The Register to Read Data				The Number of Registers to Read Data				CRC Check Codes				
0x01	0x04			0x00		0x06		0x00		0x02		0x91		0xca		Hexadecimal Data
0x30	0x31	0x30	0x34	0x30	0x30	0x30	0x36	0x30	0x30	0x30	0x32	0x39	0x31	0x63	0x61	ASCII Coded Data
"0"	"1"	"0"	"4"	"0"	"0"	"0"	"6"	"0"	"0"	"0"	"2"	"9"	"1"	"c"	"a"	ASCII Character

Note: the first address of the register of the meter L1 current is 00 06 and the number of registers is 2.

2) After receiving the above command, the meter will return the current L1 current data of the meter, as shown in the following table after ASCII coding.

Reserved	Function Code			The Length of Data Returned				current L1 current data of the meter				CRC Check Codes								
0x01	0x04			0x04				0x40		0xa0		0x00		0x00		0xee		0x66		Hexadecimal Data
0x30	0x31	0x30	0x34	0x30	0x30	0x34	0x30	0x61	0x30	0x30	0x30	0x30	0x30	0x65	0x65	0x36	0x36	ASCII Coded Data		
"0"	"1"	"0"	"4"	"0"	"0"	"4"	"0"	"a"	"0"	"0"	"0"	"0"	"0"	"e"	"e"	"6"	"6"	ASCII Character		

Note: Assume that the current meter's L1 current is 5.0A, since the data is in floating point format, the Hex data is converted to 0x40, 0xa0, 0x00 and 0x00.

To ensure the successful communication, below information must be confirmed:

1. The command is sent through Class C mode.
2. The command is sent in ASCII format.

2. Start Up Screens

	<p>The first screen lights up all display segments and can be used as a display check.</p>
--	--

	<p>The second screen indicates the firmware version. (left picture is for reference only)</p>
	<p>The interface performs a self-test and indicates the result if the test passes.</p>

*After a short delay, the screen will display active energy measurements.

3. Measurements



The buttons operate as follows:

	<p>Selects the Voltage and Current display screens In Set-up Mode, this is the “Left” or “Back” button.</p>
	<p>Select the Frequency and Power factor display screens In Set-up Mode, this is the “Up” button</p>
	<p>Select the Power display screens In Set-up Mode, this is the “Down” button</p>
	<p>Select the Energy display screens In Set-up mode, this is the “Enter” or “Right” button</p>

3.1 Voltage and Current

Each successive pressing of the  button selects a new range:

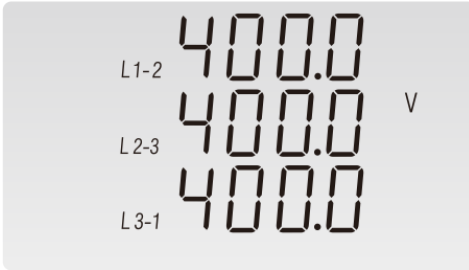
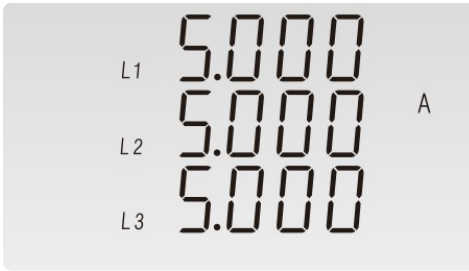
	<p>Phase to neutral voltages</p>
--	----------------------------------

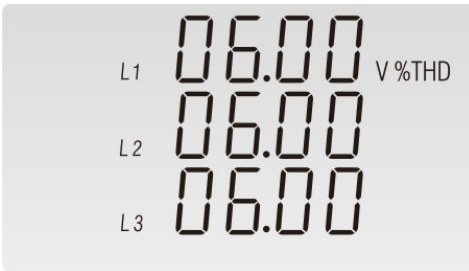
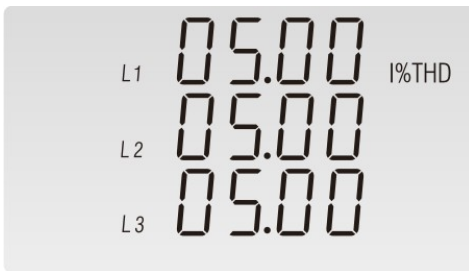
	Phase to Phase Voltages
	Current on each phase
	Neutral Current
	Phase to neutral voltage THD%
	Current THD% for each phase

3.2 Frequency and Power factor and Demand

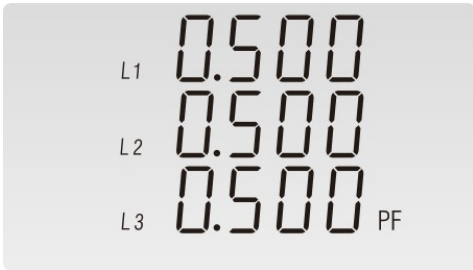
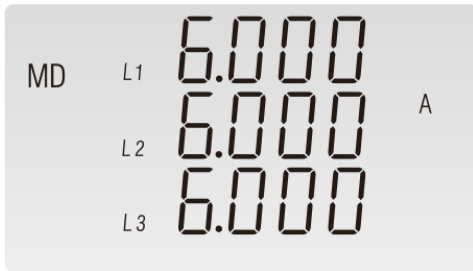
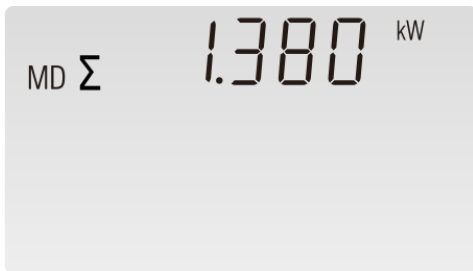

Each successive pressing of the  button selects a new range:

	Frequency and Power Factor (total)
	Power Factor of each phase
	Maximum Current Demand
	Maximum Power Demand

3.3 Power

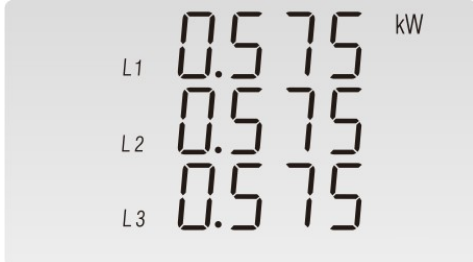
Each successive pressing of the  button select a new range:

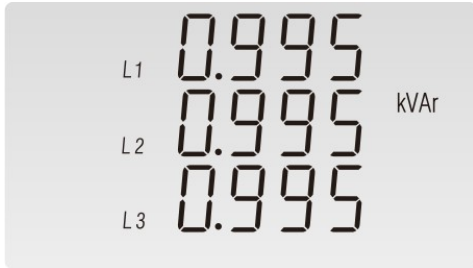
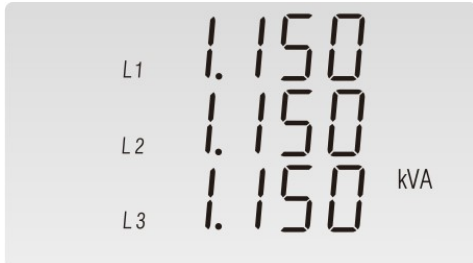
	Instantaneous Active Power in kW
---	----------------------------------

	Instantaneous Reactive Power in kVAr
	Instantaneous Volt-amps in KVA
	Total kW, kVArh, kVA

3.4 Energy Measurements

Each successive pressing of the  button selects a new range:

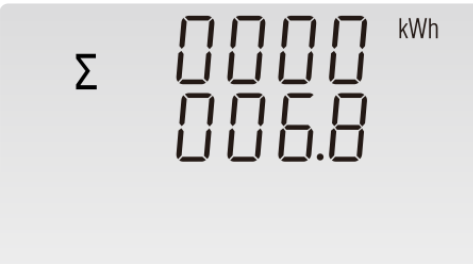
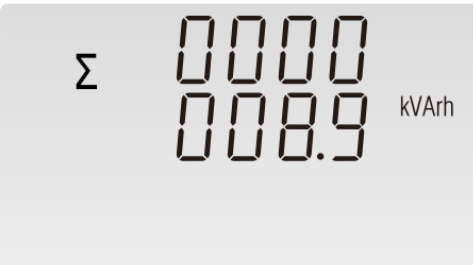
	Total active energy in kWh
	Imported active energy in kWh Total reactive energy in kVArh

	Imported active energy in kWh
	Exported active energy in kWh
	Imported reactive energy in kVAh
	Exported reactive energy in kVAh
	Meter ID (Serial Number)

4. Setting Up

To enter set-up mode, pressing the



button for 3 seconds, until the password screen appears.



Setting up is password-protected so you must enter the correct password before processing. If an incorrect password is entered, the display will show: PASS Err

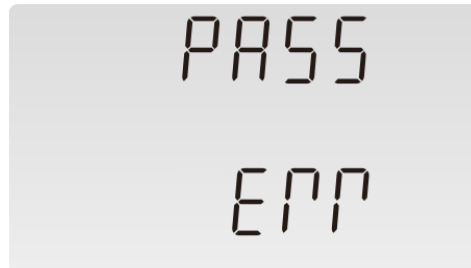











To exit setting-up mode, press  repeatedly until the measurement screen is restored.

4.1 Set-up Entry Methods









Some menu items, such as password and CT, require a four-digit number entry while others, such as supply system, require selection from a number of menu options.

4.1.1 Menu Option Selection

- 1) Use the  and  buttons to select the required item from the menu shown in section 4.1.
- 2) Press  to confirm your selection
- 3) If an item flashes, then it can be adjusted by the  and  buttons. If not, there maybe a further layer.
- 4) Having selected an option from the current layer, press  to confirm your selection.
- 5) Having completed a parameter setting, press  to return to last menu. and you will be able to use the  and  buttons for further menu selections.
- 6) After completing all setting-up, press  repeatedly until exit the setting mode.

4.1.2 Number Entry Procedure









When Setting up the unit, some screens require the entering of a number. E.g. the setting of password. Digits are set individually, from left to right. The procedure is as below:

- 1) Use the  and  buttons to select the required item from the menu shown in section 4.1.
- 2) Press  for 3s to confirm your selection
- 3) The current digit to be set flashes and press the  and  button to choose the required digit.
- 4) Press  to move to the next digit.
- 5) After setting the last digit, press  for 3s to confirm your setting. And press  repeatedly until exit the setting mode.

4.2 Setting 1











Input Password "1000", press  for 3s to enter into the setting up page.

4.2.1 CT2









	<p>Use  and  to find the secondary current input setting.</p> <p>Options: 5A or 1A Default CT2: 5A</p>
	<p>Press  for 3s, the current digit will flash.</p> <p>Press  or  to choose the selection.</p>
	<p>Press  for 3s to confirm.</p>



Press  to exit the setting mode

4.2.2 CT1









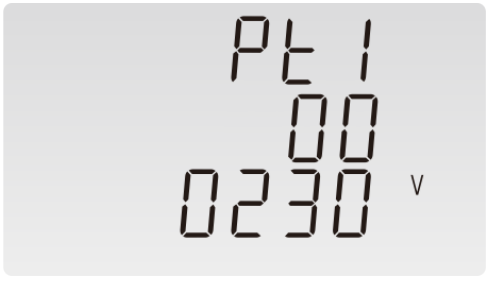

	<p>Use  and  to find the primary current input setting.</p> <p>Options: 1-9999A Default CT1: 5A</p>
	<p>Press  for 3s, the current digit will flash.</p> <p>Press  or  to choose the selection.</p>
	<p>Press  for 3s to confirm.</p>
<p>Press  to exit the setting mode</p>	

4.2.3 PT2

	<p>Use  and  to find the PT set up menu.</p> <p>Options: 30-500V Default PT2: 230V under 3P4W mode 400V under 3P3W mode</p>
	<p>Press  for 3s, the current digit will flash.</p> <p>Use ,  and  to select PT2.</p>

	Press  for 3s to confirm.
Press  to exit the setting mode	

4.2.4 PT1









	Use  and  to find the PT set up menu. Options: 30-500000V Default PT1: 230V
	Press  for 3s, the current digit will flash. Use  ,  and  to select PT2.
	Press  for 3s to confirm.
Press  to exit the setting mode	

Note:

The PT option sets the Primary voltage and secondary voltage of the voltage transformer (PT) that give into the meter.





For example: if the PT connect to the meter is 10000/100V (Primary voltage is 10000V, secondary voltage is 100V)



4.2.5 Pulse Output Type:

	<p>Pulse Output Type Default: kVArh Range: kVArh, imp kVArh, Exp kVArh, kWh, Exp kWh, imp kWh.</p>
	<p>Press  for 3s, the red part will flash. Press  or  to choose the required selection.</p>
	<p>Press  for 3s to confirm.</p>
<p>Press  to exit the setting mode</p>	









4.2.6 Pulse Constant

Use this to set the energy represented by each pulse

	<p>Pulse Constant Default: 0.01 kWh Range: 0.001/ 0.01/ 0.1/1 / 10/ 100/ 1000 kWh (left picture means 1 impulse = 10 kWh/kVArh)</p>
	<p>Press  for 3s, the red part will flash. Press  or  to choose the required selection.</p>







	Press  for 3s to confirm.
Press  to exit the setting mode	

4.2.7 Pulse Duration









	Pulse Duration Default: 200 Range: 60/ 100/ 200 mS
	Press  for 3s, the red part will flash. Press  or  to choose the required selection.
	Press  for 3s to confirm.
Press  to exit the setting mode	

4.2.8 Demand Interval Time (DIT)







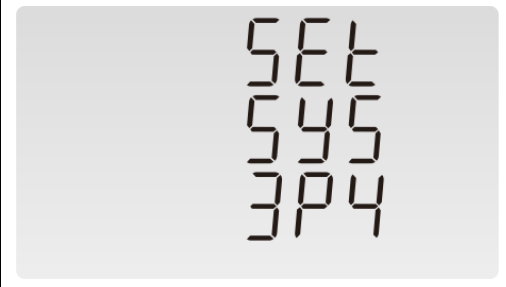

	The screen will show the currently selected integration time. Default: 60 Range: 60/ 30/ 20/ 15/ 10/ 8/ 5/ 0.
---	---

	<p>Press  for 3s, the current demand interval time will flash. Press  or  to choose the required selection.</p>
	<p>Press  for 3s to confirm.</p>
<p>Press  to exit the setting mode</p>	

4.2.9 Backlight Time (LP)







	<p>The screen will show the currently selected backlight time. Default: 60 minutes Range: 120/ 60/ 30/ 10/ 5/ON/ OFF If it is seated as 5, the backlit will be off in 5 minutes. If it is set as ON, the backlit will always be on.</p>
	<p>Press  for 3s, the current backlight time will flash. Press  or  to choose the required selection.</p>
	<p>Press  for 3s to confirm.</p>
<p>Press  to exit the setting mode</p>	

4.2.10 System

	<p>The screen shows the currently selected power supply is three phase four wire.</p> <p>Default: 3P4W</p> <p>Range: 1P2W/ 1P3W/ 3P3W/ 3P4W</p>
	<p>Press  for 3s, the current system type will flash. Press  or  to choose the required system.</p>
	<p>Press  for 3s to confirm.</p>
<p>Press  to exit the setting mode</p>	









4.2.11 Clear Demand Information

This option is to reset the demand information. It would reset current and power demand information.

	<p>From the Set-up menu, use  and  buttons to select the reset option.</p>
	<p>Press  for 3s to enter the selection routine. The MD will flash.</p> <p>Press  again for 3s to confirm the resetting.</p>



Press  to exit the setting mode

4.2.12 Password

	<p>The screen shows the current password. Default: 1000 Range: 0001-9999</p>
	<p>Press  for 3s, the current digit will flash. Press  or  to choose the required digit, press  to move to the next digit.</p>
	<p>Press  for 3s to confirm.</p>
<p>Press  to exit the setting mode</p>	

4.2.13 System Connect

This unit provides a function with Reverse connected current inputs correction setting.

	<p>From the Set-up menu, use  and  buttons to select the option.</p>
---	--





	<p>Press for 3s to enter the Phase 1 correction.</p> <p>Options: Frd (forward) and rEv (reverse) The default is FRD (forward)</p>
	<p>Press again for 3s, the current “Frd” will flash. Use and to choose the option.</p>
	<p>Press for 3s to confirm</p>
	<p>Press to move to the phase 2 or phase 3 correction. Same operation as phase 1.</p>
<p>Press to return to the previous setting page. Press again to exit the setting mode</p>	

4.2.14 Checking Meter Information



This function allows to check meter setting information, also some of below information can be set through another password (refer to section 4.3).

1) Join Information

<p>1</p>		<p>Activation Way: OTAA</p> <p>DevEui: end-device identifier</p> <p>***** (16 digits)</p>
----------	--	---

1-1		<p>Activation Way: ABP</p> <p>DevAddr: End-device address</p> <p>***** (8 digits)</p>
2		<p>Activation Way: OTAA</p> <p>AppEui: application identifier</p> <p>***** (16 digits)</p>
2-1		<p>Activation Way: ABP</p> <p>NwkSKey: Network session key</p> <p>***** (32 digits)</p>
3		<p>Activation Way: OTAA</p> <p>AppKey: Application key</p> <p>***** (32 digits)</p>
3-1		<p>Activation Way: ABP</p> <p>AppSKey: Application session key</p> <p>***** (32 digits)</p>

2) Join Status



1		JOIN OK Means the meter is connected to the gateway successfully
1-1		JOIN FAIL Means the meter is failed to connect to the gateway Meanwhile, the display will show EER1
1-2		JOIN WAIT Means the meter is in the process of joining.

3) Join Mode

1		JOIN MOdE: OTAA
1-2		JOIN MOdE: Abp

4) AUTO

When AUTO function is ON, the meter will send a command to gateway automatically to check the connection status with gateway. Interval time is configurable.



1		AUTO
1-2		UP LOAD: ON Means AUTO function is open, otherwise it will show OFF
1-3		Interval Time Option: 5/ 10/ 20/ 30/ 90/ 120/ 150/ 180/ 210/ 240 minutes

5) Meter ID

1		Meter ID/ Serial Number ***** (8 digits)
---	---	--

4.3 Setting 2

Input Password "6308", press  and  together for 3s to enter the setting up page.



















The first page will show join status between the meter and gateway. Use  and  to choose the options required.

Below information can be adjusted through password "6308":

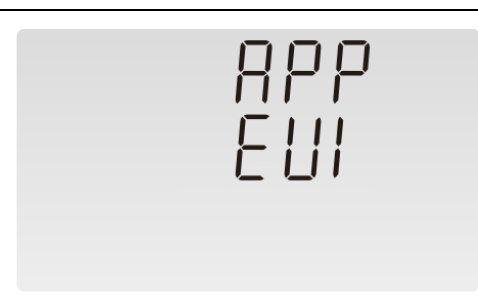





4.3.1 Join Information:

Join information including DevEui, AppEui, Appkey under OTAA mode and DevAddr, NwkSKey, AppSKey under ABP mode.





Take OTAA setting as an example:

	<p>DevEui: 913200001324013</p> <p>The 16 digits will be shown on 2 pages. Each page shows 8 digits.</p> <p>Press  for 3s, enter into the P1 setting page.</p>
	<p>Press  for 3s, the first digit will flash. Use ,  and  to choose the option.</p> <p>Press  for 3s again to confirm the setting.</p>
	<p>Press  to move to the P2 setting page.</p> <p>Use ,  and  to do the same operation as P1.</p>
	<p>After P2 setting, Press  return to the DevEui page, press  move to the next setting page: AppEui and Appkey.</p> <p>Use the same way to set AppEui and Appkey.</p>
	<p>After above setting, Press  return to the main setting page.</p> <p>Press  to move to the SAVE page. Long Press  button for twice to save above setting.</p>

4.3.2 Join Mode: OTAA/ ABP

	<p>Join mode Option: OTAA, ABP</p>
	<p>Press  for 3s, the current option will flash. Use  and  to choose the option.</p>
	<p>Press  for 3s to confirm.</p>













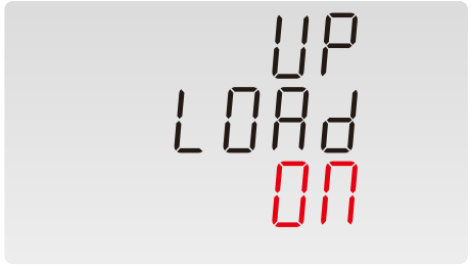

4.3.3 Re-Join

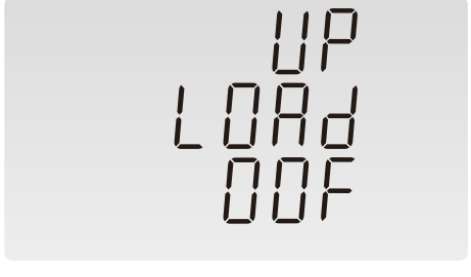

	<p>Re-Join This function allows the meter re-join the network when disconnected.</p>
	<p>Press  for 3s, the current option will flash. Long press  again, the meter will re-join the network automatically.</p>

4.3.4 Auto: Upload ON/OFF, Upload Interval Time

When Auto is ON, the meter will send a command to gateway automatically. This is for the gateway to check if the meter is still online.

Under Active upload mode, the Auto function is not used.











	<p>From the Set-up menu, use  and  buttons to select the AUTO option.</p> <p>Press  for 3s enter to the setting page.</p>
	<p>UP LOAd: ON Range: ON/OFF</p> <p>Press  for 3s, the current option will flash.</p> <p>Use  or  to choose the option.</p>
	<p>Press  for 3s to confirm.</p>
	<p>Interval Time Option: 5/ 10/ 20/ 30/ 90/ 120/ 150/ 180/ 210/ 240 minutes</p> <p>05 means the meter will send a command to gateway every 5 minutes.</p>
	<p>Press  for 3s, the current option will flash.</p> <p>Use  or  to choose the option.</p>

	Press  for 3s to confirm.
---	--

4.3.5 Join Delay

When Join delay function is ON, the meter will join the LoRaWAN network with a few seconds delay after booting.







When Join delay function is OFF, the meter will join the LoRaWAN network once the power is on.

	From the Set-up menu, use  and  buttons to select the JOIN DLY option. Press  for 3s enter to the setting page.
	UP LOAD: ON Range: ON/OFF Press  for 3s, the current option will flash. Use  or  to choose the option.
	Press  for 3s to confirm.

4.3.6 OFF Line

This function is used to check the connection status between meter and the network/gateway.

To check the connections, the network will send data to the end-device at intervals. If over a period, the meter doesn't receive data from gateway, the meter will be considered OFF line and it will re-join the network.



	<p>OFF Line Option: OFF/ 30/ 60/ 90/ 120/ 150/ 180/ 210/ 240 minutes Default: 60 minutes 60 minutes means from the last message received from gateway, if over 60 minutes not receiving message, the meter will be considered OFFLINE and will re-join the network automatically.</p>
	<p>Press  for 3s, the current option will flash. Use  or  to choose the option.</p>
	<p>Press  for 3s to confirm.</p>







NOTE: Under the active upload mode, the OFF Line time should be set to a value bigger than the active upload interval time.

4.3.7 Confirm Mode

When the Confirm mode is ON, the meter will request the LoRaWAN network to confirm the reception of its message.

If there is no message received, it means the network has not received the uplink. The Meter will send uplink again, upon to 3 times.

	<p>From the Set-up menu, use  and  buttons to select the Confirm mode option.</p>
---	---

	<p>Press  for 3s, the current option will flash.</p> <p>Use  or  to choose the option.</p>
	<p>Press  for 3s to confirm.</p>

5 Specifications

Electrical characteristics			
Type of measurement	RMS including harmonics on three phase AC system (3P, 3P+N)		
Measurement accuracy	Active Energy	IEC 62053-21 Class 1	
	Reactive Energy	± 0.01	
	Frequency	± 0.2%	
	Current	± 0.5%	
	Voltage	± 0.5%	
	Power	± 0.01	
	Power Factor	± 0.01	
Data Update Rate	1 second nominal		
Input-Voltage	VT Primary	30 ~ 500000 Vac	
	Un	230 V L-N	
	Measured Voltage with Over-range	173 to 480 Vac L-L 100 to 276 Vac L-N	
	Impedance	1M Ω	
	Frequency Range	45~65Hz	
Input- Current	CT	Primary	
	Ratings	Secondary	
	Measured current with Over-range	1~9999A 1A / 5A	
	Withstand	5mA~6A Continuous 8A 120A for 0.5 Seconds	
	Impedance	<1M Ω	
	Frequency Range	45~65Hz	

	Burden	<0.036VA at 6A
Auxiliary Power Supply	Operating Range	85~275V AC / 120~380V DC
	Power Consumption	< 7VA/3.5W.
	Frequency	45 to 65 Hz
Max. reading		9999999.9 kWh/ kVArh
Mechanical Characteristics		
Weight		300g
IP Degree of Protection (IEC 60529)		IP51 (indoor)
Dimensions (WxHxD)		72x94.5x65mm
Mounting		Din rail (DIN 43880)
Material of meter case		Self-extinguishing UL 94 V-0
Mechanical environment		M1
Environmental Characteristics		
Operating Temperature		-25 to 55°C
Storage Temperature		-40 to 70°C
Humidity Rating		<95% RH at 50 °C (non-condensing)
Pollution Degree		2
Altitude		2000m
Vibration		10Hz to 50Hz, IEC 60068-2-6
Safety		
Measurement Category		Per IEC61010-1 CAT III
Current Inputs		Require external Current Transformer for Insulation
Over voltage Category		CAT III
Dielectric Withstand		As per IEC 61010-1 Double Insulated front panel display
Protective Class		II
Communications		
Interface standard and protocol		LoRaWAN Specification 1.0.2
Frequency		EU868/AS923/AU915/ US902/CN470/CN433
LoRaWAN Classes		Class C
Auto-upload		Max. 30 parameters
Auto-upload Interval		Configurable
Activation Way		OTAA or ABP
Output Power		13dBm in transmission
Coding Format		ASCII
Communication Distance		3000M in an open area

NOTE:

Voltage inputs through 4-way fixed connector with 2.5mm² stranded wire capacity. single phase two wire(1p2w), three phase three wire(3p3w) or four phase four wire(3p4w) unbalanced. Line frequency measured from L1 voltage or L3 voltage.

Three current inputs (six physical terminals) with 2.5mm² stranded wire capacity for connection of external CTs. Nominal rated input current 5A or 1A a.c. Rms.

6 Maintenance

In normal use, little maintenance is needed. As appropriate for service conditions, isolate electrical power, inspect the unit and remove any dust or other foreign material present. Periodically check all connections for freedom from corrosion and screw tightness, particularly if vibration is present.

The front of the case should be wiped with a dry cloth only. Use minimal pressure, especially over the viewing window area. If necessary, wipe the rear case with a dry cloth. If a cleaning agent is necessary, isopropyl alcohol is the only recommended agent and should be used sparingly. Water should not be used. If the rear case exterior or terminals should be contaminated accidentally with water, the unit must be thoroughly dried before further use. Should it be suspected that water might have entered the unit, factory inspection and refurbishment is recommended.

In the unlikely event of a repair being necessary, it is recommended that the unit be returned to the factory or nearest Eastron distributor.

7 Installation**7.1 Safety**

The unit is designed in accordance with IEC 61010-1:2017 – Permanently connected use, Normal condition. Installation category III, pollution degree 2, basic insulation for rated voltage.

7.2 EMC Installation Requirements

Whilst this unit complies with all relevant EU EMC (electro-magnetic compatibility) regulations, any additional precautions necessary to provide proper operation of this and adjacent equipment will be installation dependent and so the following can only be general guidance:

Avoid routing wiring to this unit alongside cables and products that are, or could be, a source of interference.

The auxiliary supply to the unit should not be subject to excessive interference. In some cases, a supply line filter may be required.

To protect the product against incorrect operation or permanent damage, surge transients must be controlled. It is good EMC practice to suppress transients and surges at the source. The unit has been designed to automatically recover from typical transients; however, in extreme circumstances it may be necessary to temporarily disconnect the auxiliary supply for a period of greater than 10 seconds to restore correct operation.

Screened communication leads are recommended and may be required. These and other connecting leads may require the fitting of RF suppression components, such as ferrite absorbers, line filters etc., if RF fields cause problems.

It is good practice to install sensitive electronic instruments that are performing critical functions in EMC enclosures that protect against electrical interference causing a disturbance in function.



Warning

- **During normal operation, voltages hazardous to life may be present at some of the terminals of this unit. Installation and servicing should be performed only by qualified, properly trained personnel abiding by local regulations. Ensure all supplies are de-energized before attempting connection or other procedures.**
- **Terminals should not be user accessible after installation and external installation provisions must be sufficient to prevent hazards under fault conditions.**
- **This unit is not intended to function as part of a system providing the sole means of fault protection - good engineering practice dictates that any critical function be protected by at least two independent and diverse means.**
- **The unit does not have internal fuses therefore external fuses must be used for protection and safety under fault conditions.**
- **Never open-circuit the secondary winding of an energized current transformer.**
- **This product should only be operated with CT secondary connections Earthed.**
- **If this equipment is used in a manner not specified by the manufacturer, protection provided by the equipment may be impaired.**

7.3 Dimensions

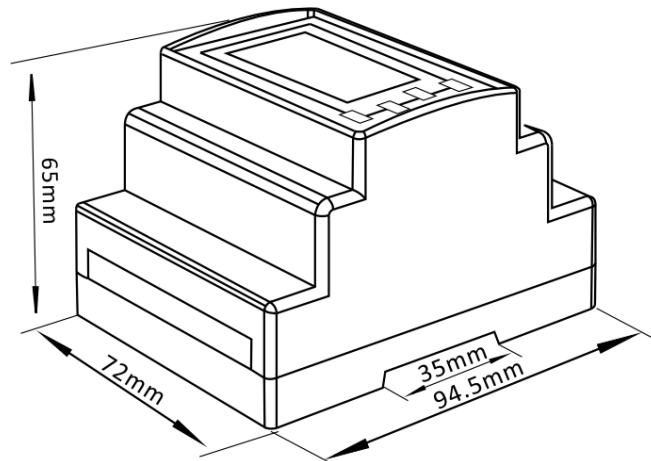

7.4 Wiring Diagram

7.4.1 Current and Voltage Input

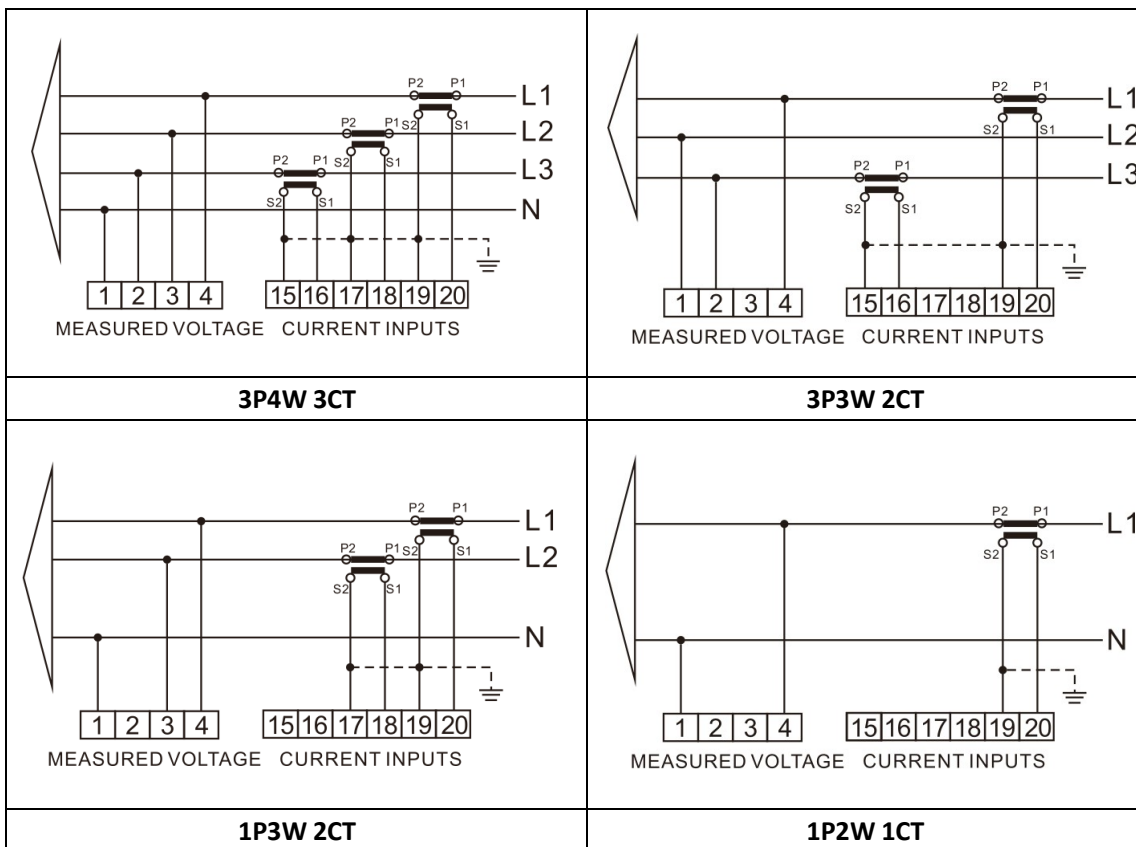

7.4.2 Definitions of Other Terminals

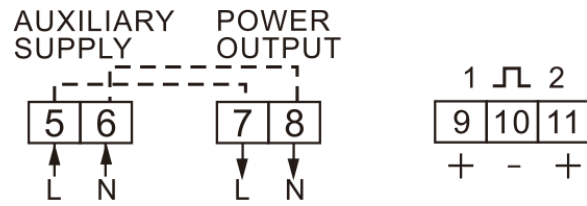

.....END.....

If you have any question, please feel free to contact us at:

Eastron Europe Ltd.

Add: 12 Brunel Road, Benfleet, Essex, SS7 4PS, United Kingdom

T: 0203 7583494

E: sales@eastroneurope.com